

FRICO

Thermozone

AD210C03

AD210C05

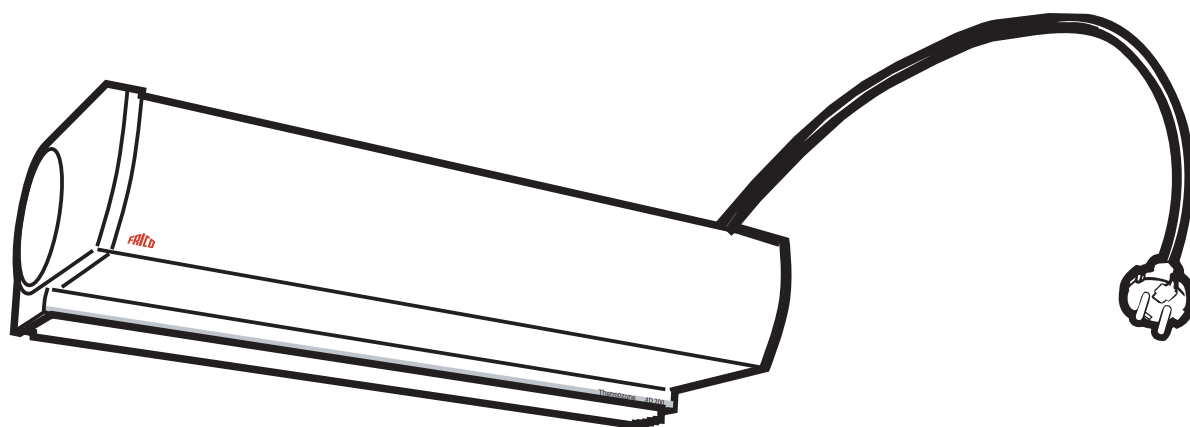

Thermozone AD210C03 / AD210C05

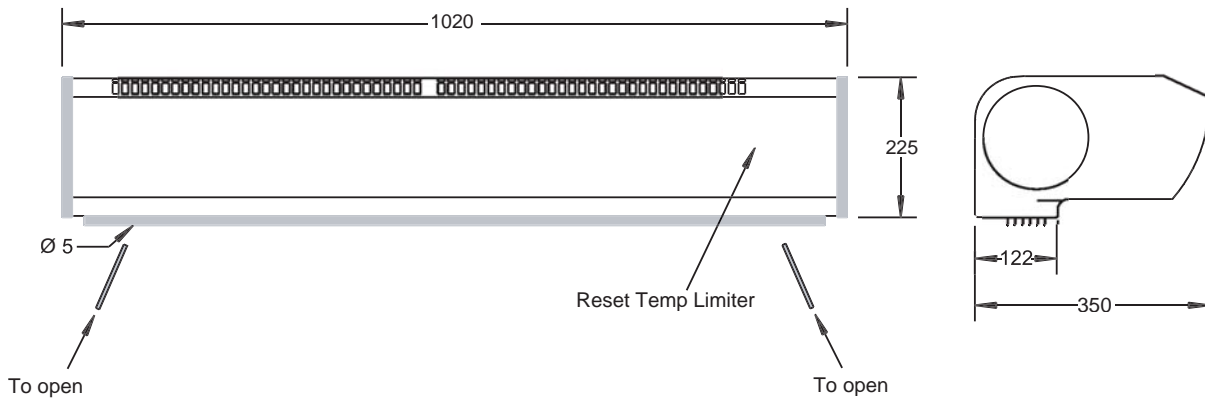

Mounting alternatives

(A, B and C, standard brackets included in delivery, D and E, accessories)

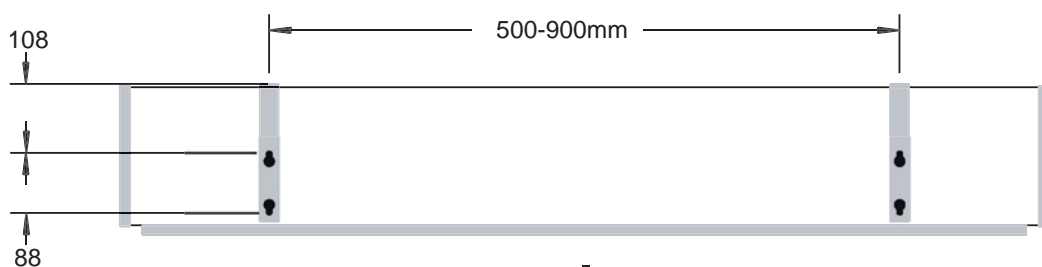
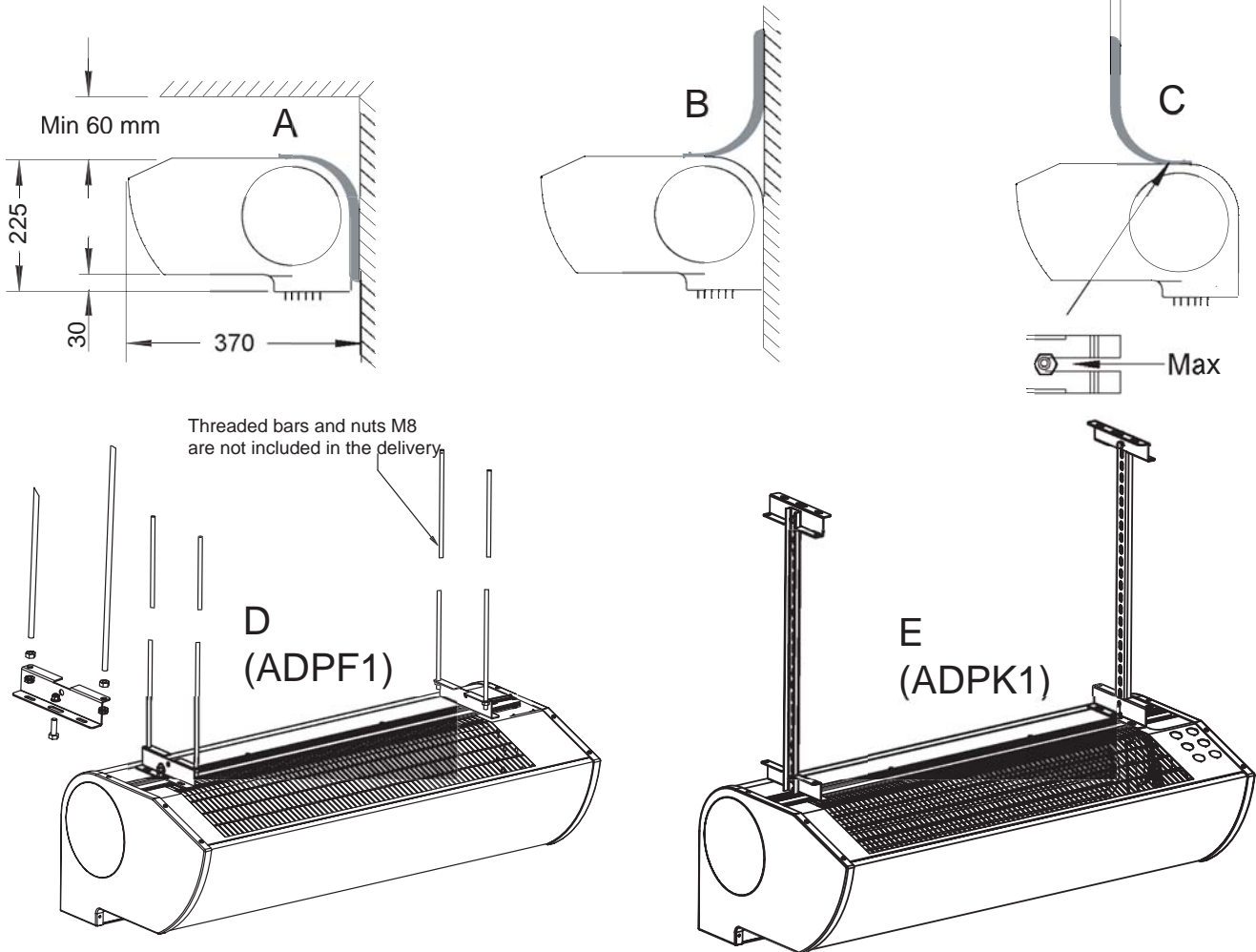

Thermozone AD210C03 / AD210C05

AD210C03

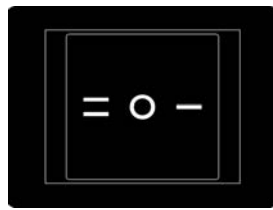
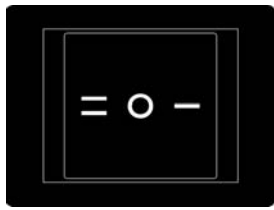

2 kW



900 m3/h



3 kW



1400 m3/h

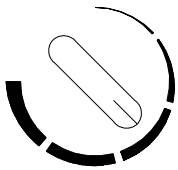

Thermostat
5 - 35 °C



14 kg



(IP 21)

AD210C03

+10 / 7 °C

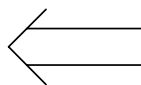

41 / 51 dB(A)

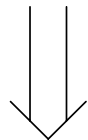

230 V~, 50 Hz, 13,5A

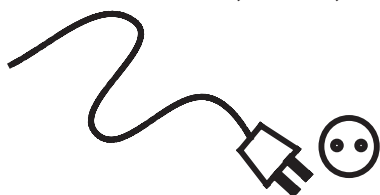

16 A

AD210C05

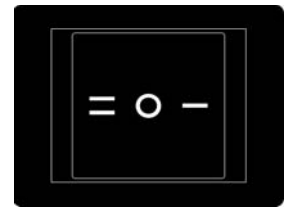
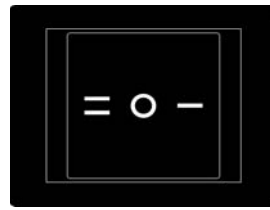

3 kW



900 m3/h



4,5 kW



1400 m3/h

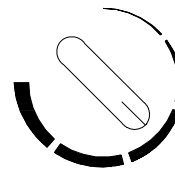

Thermostat
5 - 35 °C



14 kg



(IP 21)

AD210C05

+15 / 11 °C

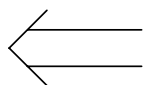

41 / 51 dB(A)

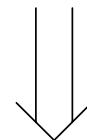

230 V~, 50 Hz, 20,1A



20/25A

Thermozone AD210C03 / AD210C05

Säkerhet



Apparaten har vid drift heta ytor!
Apparaten får ej placeras så att brännbart material kan antändas!
Apparaten får ej övertäckas helt eller delvis med kläder eller dylikt material, då överhettning av apparaten kan medföra brandfara!

Sikkerhet



Ved drift har apparatet varme overflater!
Apparatet må ikke plasseres slik at brennbart materiale kan antennes!
Apparatet må ikke tildekkes helt eller delvis med klær eller lignende materiale, da overoppheting av apparatet kan medføre brannfare!

Turvallisuus



Laitteessa on pintoja, jotka kuumenevat käytön aikana!
Laitetta ei saa sijoittaa helposti syttyvän materiaalin lähelle!
Laitetta ei saa peittää kokonaan tai osittain vaatteilla ja vastaavilla materiaaleilla, sillä laitteen ylikuumentuminen voi aiheuttaa tulipalon vaaran!

Sicherheit



Das Gerät hat beim Betrieb heisse Flächen.
Das Gerät darf nicht so aufgestellt werden, daß brennbares Material Feuer fangen kann.
Das Gerät darf nicht teilweise oder vollständig mit Kleidungsstücken überdeckt werden, da dies zu Überhitzung des Geräts und Feuergefahr führen kann.

Main office

Frico AB
Box 102
SE-433 22 Partille
Sweden

Tel: +46 31 336 86 00
Fax: +46 31 26 28 25
e-mail: mailbox@frico.se
www.frico.se

Norway

Frico AS
Postboks 82, Alnabru
NO-0614 Oslo
Norway

Tel: +47 233 719 00
Fax: +47 233 719 10
e-mail: mailbox@frico.no
www.frico.no

France

Frico France
7, rue de la libération
FR-69 270 Fontaines sur Saone
France

Tel: +33 4 72 42 99 42
Fax: +33 4 72 42 99 49
e-mail: info@frico.fr
www.frico.fr

Sûreté



Les surfaces de l'appareil sont chaudes lorsqu'il est en fonctionnement
Ne pas placer l'appareil de manière qu'il puisse mettre feu à un matériau inflammable. Ne pas recouvrir l'appareil ni complètement, ni partiellement, par des vêtements et autres, une surchauffe de celui-ci pouvant provoquer un incendie.

Veiligheid



Het apparaat heeft hete oppervlakken wanneer het in werking is.
Het apparaat mag niet zodanig worden geplaatst dat het gevaar bestaat brandbare materialen aan te steken! Het apparaat mag niet geheel of gedeeltelijk overdekt worden met kleding e.d., aangezien oververhitting van het apparaat brandgevaar met zich mee kan brengen!

Safety



The unit has hot surfaces when running!
The unit must not be positioned so that inflammable material can ignite!
The unit must not be covered fully or partially with clothes, or similar materials, as overheating can result in a fire risk!

Меры безопасности



При работе поверхность аппарата нагревается! Аппарат не должен располагаться вблизи легковоспламеняющихся материалов!
Нельзя накрывать аппарат полностью или частично одеждой или чем-либо другим. В этом случае может возникнуть перегрев и создается опасность возгорания и пожара!

United Kingdom

Frico UK
Pharaoah House
Arnolde Close,
Medway City Estate
UK- Rochester KEnt ME2 4SP
United Kingdom

Tel: +44 16 34 3473 5020
Fax: +44 16 34 3473 5020
e-mail: info.uk@frico.se
www.frico.se

Russia

Frico representative office in Russia
1 st Golutvinsky per., 3
RU-Moscow 109180
Russia

Tel: +7 095 238 63 20
Fax: +7 095 238 64 20
e-mail: frico@trankm.ru
www.frico.se

China

Frico representative office in China
No. 285, Luo Chuan Rd (E)
Europe City, Room 420
CN-Shanghai 200020
P. R. China

Tel: +86 21 6467 9611
Fax: +86 21 6415 2081
e-mail: frico@sohu.com
www.frico.se